

Product
Sheet

Fully ergonomic,
adjustable,
space-saving
ARMS for flat
panel monitors



200 Arm
shown folded
back and fully
extended.



Ergotron® ARMS™

200 Series

Attach your flat panel monitor(s) to a 200 Series Arm and free up desk space while adding greater range of movement. You can easily customize a solution from the 200 Series' wide selection of interchangeable components. Use a single Extension or combine more* according to your application needs. Swing, tilt or turn your flat panel monitors for maximum efficiency and ergonomic comfort. Arms fold back out of the way when you need more access to your worksurface.

The 200 Series attaches to virtually any work area; select a Slatwall, Desk Clamp, Wall Track or Grommet/Direct Mount interface.

* More than two Extensions can be used if weight of configuration doesn't exceed weight capacity formula. See Orderguide (870-03-005), Web site or Ergotron Representative for more information.

Features

- Arms telescope in and out up to 20" (508 mm) when using two* Extensions
- Easily position the angle of your monitor for maximum comfort and productivity
- Handles most flat panel monitors up to 28 lbs (12.7 kgs), depending on configuration*
- Interfaces available for virtually any surface or slatwall
- Patented friction system provides smooth long-life adjustment while maintaining touch-screen stability
- Up to five pivot points, all have independently adjustable friction control for unequalled adjustability
- Rugged construction ensures long-lasting durability
- Cable management system organizes and routes cables neatly
- Ideal for 30" to 43" deep financial trader desks
- Video Electronics Standards Association (VESA®) FPMPTM compliant for 75 mm or 100 mm Mounting Interface Standard
- Designed to interface with the 300 Series Arm for vertical adjustment
- Interchangeable components let you customize your solution
- 5-year warranty



Maximize the effectiveness of your flat panel monitors

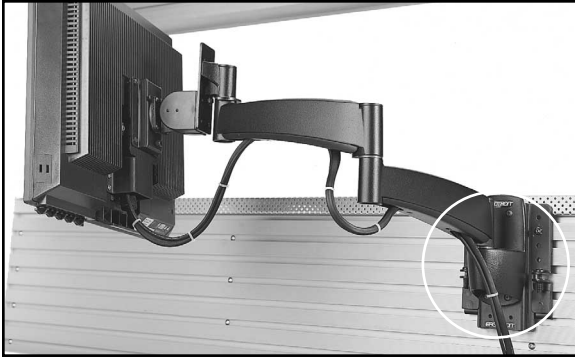

Integrated Cable Management: Organize and route cables through the Extension Arms. Select a Vertical Mount Base (shown above), Desk Clamp Base, or Grommet Mount Base according to your application.

Vertical (right top) and Horizontal (right bottom) Dual-Monitor configurations attached to an Ergotron Slatwall Bracket.



200 Arms enhance a financial trader desk by allowing the monitors to be positioned in parabolic configurations for simultaneous viewing.

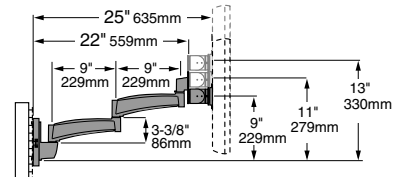

Configuration Options:

Select one of these configurations or build your own. Many other pre-configured variations exist.

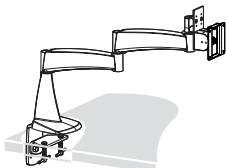

28-097-200, Desk Clamp Base, Single Pivot w/ P/L

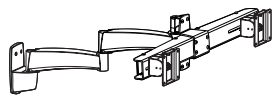

28-147-200, Vertical Mount Base, (2) Single Pivots w/ P/L

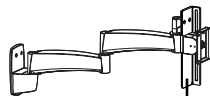

28-153-200, Vertical Mount Base, Single Pivot w/ P/L
6" Vertical Adjustment Extension

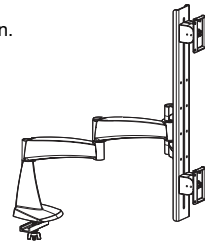

28-146-200, Grommet Mount Base, (2) Single Pivots w/ P/L

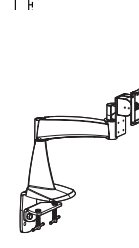

28-117-200, Desk Clamp Base, Single Pivot w/ P/L



28-106-200, Vertical Mount Base, Single Pivot w/ P/L



28-115-200, Desk Clamp Base, Single Pivot w/ P/L

General Features:

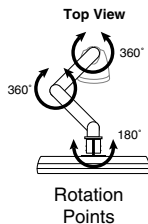
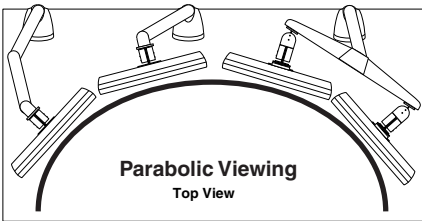

Rotation Points

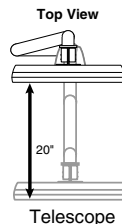

Telescope

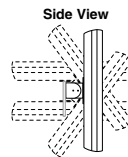

125°-180° monitor tilt

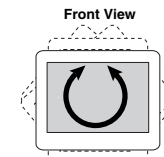

360° portrait/landscape (P/L)

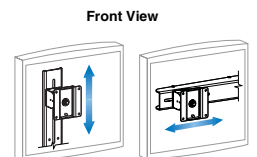

Adjustable monitor position, use thumbscrew on back

Monitors can be arranged in a **Viewing Parabola** to increase data visibility, maintain a single focal length for viewer's eyes (less work for eye muscles) and utilize available space efficiently.

Basic Specifications:

Application Options: Slatwall, Ergotron Wall Track, Wall Plate, Direct Mount, Desk Clamp, Grommet Mount and Pole Mount. Note: Cameras and other components can be custom-mounted on 200 Series systems.

Monitor Interface Pad Options:

- VESA FPMPMI™ 75 mm and 100 mm Interface Plate (Standard)
- Custom Interface Plate (contact Ergotron for details and availability)

Shipping Weight: 12 to 20 lbs (5.4 to 9.1 kgs)

© 2001 Ergotron, Inc.
rev. 2/08/2001 870-05-035

Ergotron, Inc.
1181 Trapp Road
St. Paul, MN 55121
(800) 888-8458
Fax (651) 681-7717
www.ergotron.com
sales@ergotron.com

Ergotron Europe
Kuiperbergweg 50
1101 AG Amsterdam
The Netherlands
Tel. +31 20 696.60.65
Fax. +31 20 609.04.59
info.eu@ergotron.com

Net Weight: 8 to 16 lbs (3.6 to 7.3 kgs)

Weight Capacity: 28 lbs (12.7 kgs) per monitor. Dual-Monitor configurations can hold two 18 lbs (8.2 kgs) monitors.

* More than two Extensions can be used if weight of configuration doesn't exceed weight capacity formula. See Orderguide (870-03-005), website or Ergotron Representative for more information.

Accessory Options: Rotation Control Kit, Quick Release Interface, Keyboard Wrist Rest, Mouse Pad, CPU Holders, Surge Suppressors and Power Strips

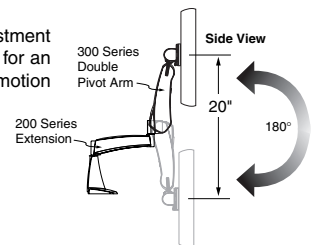

Combine a 300 Series vertical adjustment Arm with a 200 Series Extension for an optimum range of motion

